

DCC200E Series

LED Large Full Cut-Off Wall Pack

Applications

- Security, pathway and perimeter lighting
- Building entryways and walkways

Features

- Suitable for WET location/Outdoor
- Full Cutoff and compliance to Dark Sky requirement
- 90W-135W power consumption, to replace 250-400W MH
- Lumen output 9300-14000lm
- Type III polycarbonate optical lens with UV stabilizers
- 120-277V and 347V for North American
- UL/cUL
- 82 CRI



Photometrics

DCC200E90W9500LMV50K

Luminous Intensity Distribution Curve

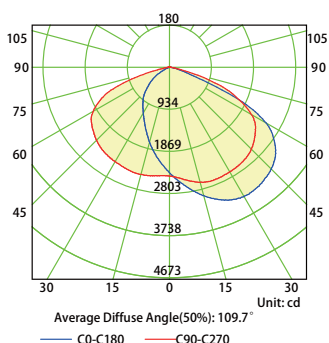

Illuminance at a Distance

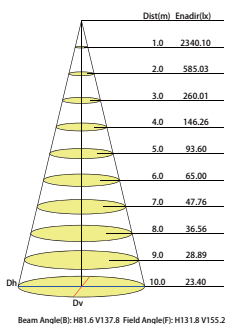

DCC200E135W14000LMV50K

Luminous Intensity Distribution Curve

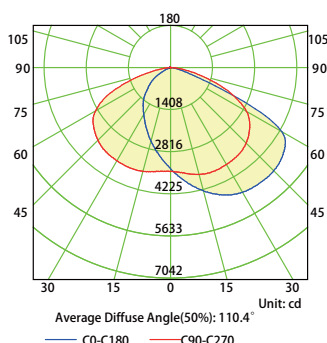

Illuminance at a Distance

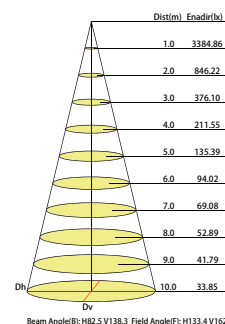

Dimensions

All dimensions are inches. Specifications subject to change without notice

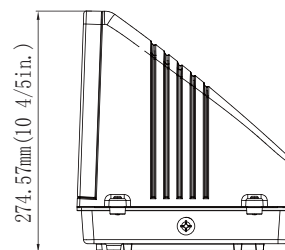
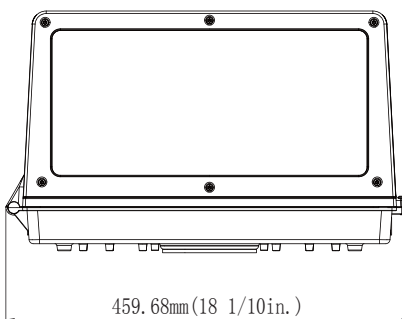
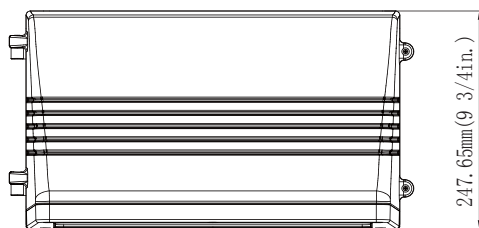

ORDERING INFORMATION

DCC200E

Series

DCC200E

45W4900L

Wattage and Lumen

90W9500L

90 System Watts,
9500 Delivered Lumens

135W14000L

135 System Watts,
14000 Delivered Lumens

MV

Driver

MV

Multi - Volt
120V-277V

50K

Kelvin Temperature

50K

5000K

Catalog Number:

Notes: